

THE *General Radio* EXPERIMENTER

VOLUME XIV NO. 3

AUGUST, 1939



ELECTRICAL MEASUREMENTS AND THEIR INDUSTRIAL APPLICATIONS

<i>Also</i>	
IN THIS ISSUE	
	Page
TYPE 700-P1 VOLTAGE DIVIDER	3
MEASURING THE FREQUENCY RESPONSE OF A SOUND SYSTEM WITH THE SOUND-LEVEL METER	4

A NEW CONDENSER FOR HIGH-FREQUENCY CIRCUITS

● THE TYPE 755-A CONDENSER is designed for use in high- and ultra-high frequency radio equipment, such as standard-signal generators, oscillators, and measuring circuits. It is a ruggedly constructed condenser, of small dimensions and capable of being set with high precision. The equivalent

series inductance is extremely low, so that it can be used as the frequency controlling element in ultra-high frequency oscillators.

The condenser is shown fully assembled in Figure 1 and with the base removed in Figure 2. As can be seen from Figure 2, the frame is a four-sided aluminum casting. The metal base, shown in Figure 1, forms a fifth-side shield. Copper-plated brass terminal strips are mounted on mycalex insulators on the unshielded side.

The drive is a worm and gear combination with a helical spring between the worm and the gear to reduce backlash to a minimum. The gear ratio is 15:1. Ball bearings are used on the main shaft. The total number of scale divisions is 1500, 15 on the main scale and 100 on the worm scale. On the drum which carries

FIGURE 1. Low inductance, low losses, small size, and precision drive are some of the features of this condenser.

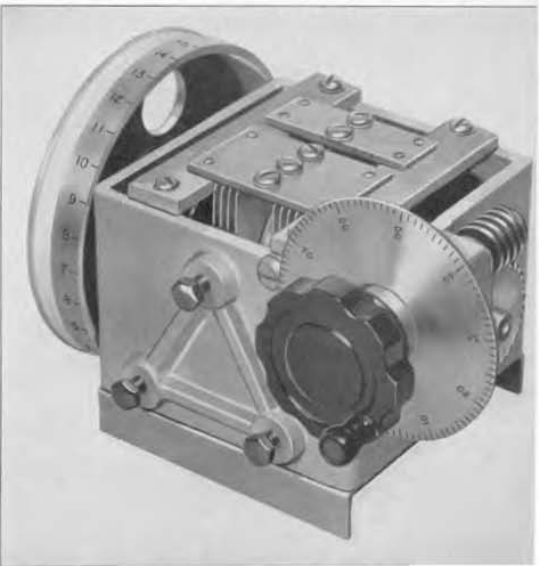

IET LABS, INC in the GenRad tradition
534 Main Street, Westbury, NY 11590

www.ietlabs.com
TEL: (516) 334-5959 • (800) 899-8438 • FAX: (516) 334-5988

the main scale, a blank paper scale is provided, so that direct-reading calibrations can be made. This paper scale is easily removable for replacement.

The plates are of brass, soldered together and heavily copper plated. Both rotor and stator are insulated from the frame. Contact to the rotor is made by a 5-finger brush bearing on a slip ring. Plates are shaped to spread out the frequency scale at the high-frequency end.

The direct capacitance from rotor to stator is variable between 8.5 μf and 145 μf . The capacitances of rotor and

stator to ground are approximately equal and are each about 10 μf .

The equivalent series inductance is about 5.5 centimeters (0.0055 μh) at minimum capacitance setting. This low inductance, combined with low effective resistance, makes the condenser an excellent tuning element at ultra-high frequencies. It can be used, in conjunction with a coil-switching system, as the frequency control in an oscillator at frequencies as high as 350 megacycles. With an "Acorn" tube, and a single-turn coil of copper ribbon, $\frac{3}{4}$ inch in diameter and $\frac{1}{2}$ inch wide, the frequency is 390 megacycles at minimum capacitance.

SPECIFICATIONS

Direct Capacitance: Maximum, 145 μf ; minimum, 8.5 μf .

Equivalent Series Inductance: 0.0055 μh at minimum capacitance setting.

Grounding: Both rotor and stator are insulated from frame. Rotor-to-frame capacitance is 10 μf ; stator-to-frame, 8 μf .

Shielding: Completely shielded on five sides; terminals brought out on unshielded side.

Mounting: The frame is drilled and threaded for a three-hole mounting, $\frac{1}{4}$ inches on centers. Threads are 8-32.

Dimensions: 6 x $5\frac{1}{2}$ x $4\frac{1}{8}$ inches, over-all, including dial and knobs.

Net Weight: 2 pounds, 10 ounces.

Type	Code Word	Price
755-A	CARGO	

FIGURE 2. View of TYPE 755-A Condenser with base removed.

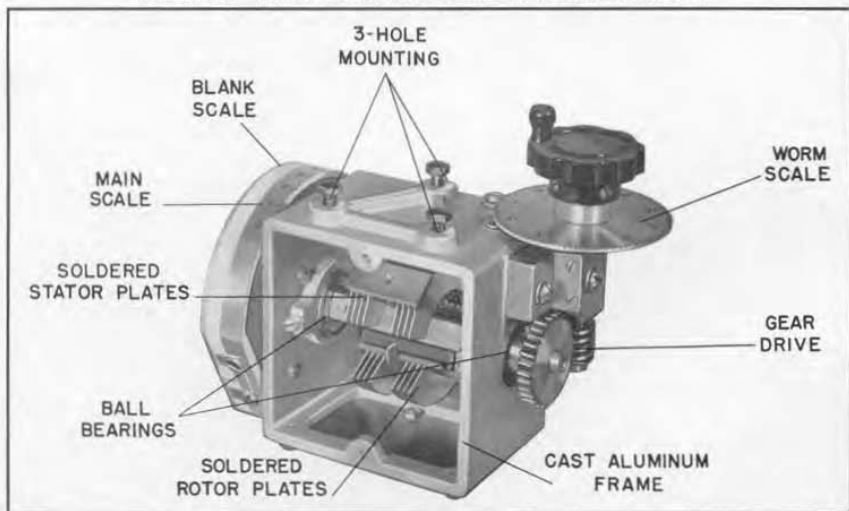

TYPE 700-P1 VOLTAGE DIVIDER

● WHEN MEASUREMENTS of amplifier gain are made, it is often desirable to know the actual magnitude of the input voltage so that the effects of background noise and overloading can be evaluated. In many cases the output voltmeter-potentiometer combination customarily supplied in beat-frequency oscillators yields a sufficiently large voltage range to meet this demand. The small input voltages required for measurements on high-gain amplifiers, however, cannot be read directly with sufficient accuracy and it is desirable to obtain the small voltages from relatively large oscillator output voltages by means of a calibrated attenuator.

The TYPE 700-P1 Voltage Divider, illustrated in Figure 1, is intended primarily for use with the TYPE 700-A Wide-Range Beat-Frequency Oscillator to furnish a range of readable output voltage from 100 microvolts to 10 volts.

It consists of a ladder-type resistive network, housed in a shielded container, with a shielded input lead and plug and output binding posts. By means of a rotary switch, multiplying factors of 0.1,

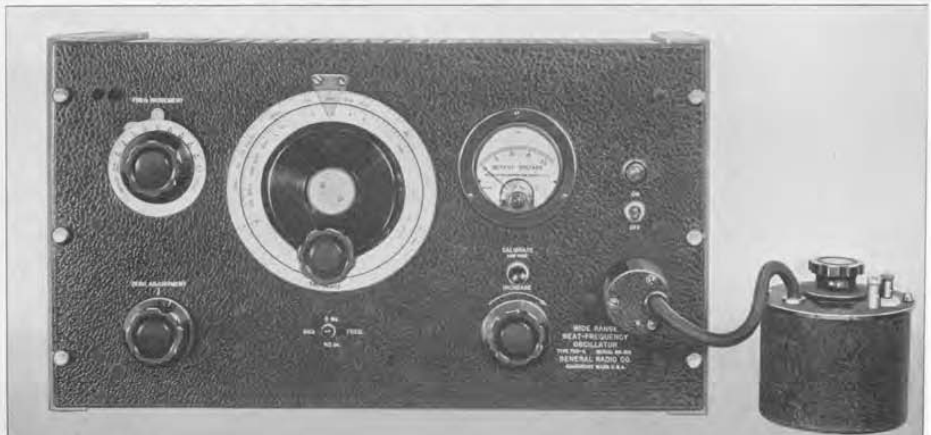

FIGURE 1. Photograph of the TYPE 700-P1 Voltage Divider showing scale, terminals, and shielded plug.

0.01, 0.001, and 0.0001 can be selected. The input impedance is 2000 ohms and the output impedance is 200 ohms. The frequency characteristic is flat within 10%, on all settings, at frequencies up to 5 Mc. A plot of the variation in attenuation with frequency for open-circuit termination is shown in Figure 3.

While primarily intended for applications involving broad frequency bands, the TYPE 700-P1 Voltage Divider is suitable for use in audio-frequency applica-

FIGURE 2. This photograph shows the TYPE 700-P1 Voltage Divider connected to the TYPE 700-A Wide-Range Beat-Frequency Oscillator.



tions where an inexpensive attenuator of moderate accuracy is required. It can be connected to any General Radio instrument having output binding posts with standard 3/4-in. spacing on centers, and the shielding of the instrument to which it is connected will ordinarily determine the lowest voltage level which can be successfully utilized at the output terminals.

— D. B. SINCLAIR

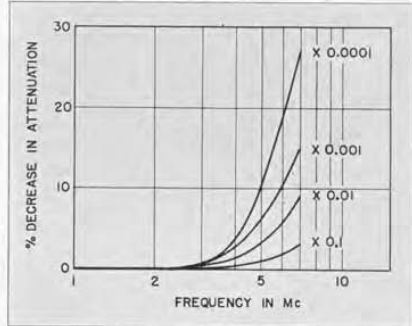

FIGURE 3. Frequency error in TYPE 700-P1 Voltage Divider.

SPECIFICATIONS

Accuracy of Attenuation: ± 3%.
 Net Weight: 1½ pounds.

Dimensions: (Not including plug and cable)
 (height) 4½ x (diameter) 4½ inches.

Type	Code Word	Price
700-P1	OTTER	

MEASURING THE FREQUENCY RESPONSE OF A SOUND SYSTEM WITH THE SOUND-LEVEL METER

● A UNIQUE FEATURE of New York's Jones Beach is the Marine Stadium shown in Figure 1. Here the stage is separated from the audience by some 50 yards of water, and a sound-amplification system is used to carry the stage

program to all parts of the grandstand.

There are five uni-directional microphones located in the footlight trough of the stage. The sound picked up by these microphones is amplified and drives eight loudspeakers located in front of the stage. The sound then must travel over the 50 yards of water before it reaches the audience in the stands.

When the microphones were first placed in the footlight trough, the amplified



FIGURE 1. View of a portion of Jones Beach, showing the Marine Stadium.



sound was very unnatural and sounded "boomy." As a result, a variable low-frequency attenuator was installed. Although this eliminated the "boom," the sound still was not natural. Since it was desired to have the volume level at the stands about the same as the volume level at the source of the sound, a linear response was sought. Although each unit of the original amplifying equipment was supposed to have fairly linear response, the over-all response sounded far from linear.

As the first step toward correction, accurate measurements were made of the over-all frequency response. This over-all frequency test included the air-transmission path from origin of sound to microphone and the air-transmission path from loudspeaker to the audience in stands as well as the complete amplifying equipment and transmission lines.

This test was made by placing an artificial voice at the sending position and an artificial ear at the receiving position.

ARTIFICIAL VOICE

The requirements for the artificial voice were that it (1) emit known frequencies at known volumes, (2) have the directional characteristics of the human head, (3) be capable of producing the same power output as the human voice, and (4) be free from distortion.

A theoretical investigation of the diffraction of sound by the human head was conducted by Stewart.* He found that a small source located on the surface of a sphere 19 cm. in diameter approximately represented the human voice in directional characteristics. The placement of a small loudspeaker in a sphere is rather difficult, but it has been found by experiment that the diffraction of sound from an equivalent cube is, for all practical purposes, the same. The

*Physical Review, 1911, page 476.



FIGURE 2. This photograph shows the artificial voice suspended before the microphone. The microphone itself is at the extreme lower right.

artificial voice finally used consisted of a box 7 inches x 7 inches x 5 inches with a small dynamic loudspeaker located in the center. The diameter of the opening was 3 inches.

ARTIFICIAL EAR

For the artificial ear a General Radio TYPE 759-A Sound-Level Meter was chosen. This meter was small and compact and could easily be carried around the stadium.

PROCEDURE OF TEST

First it was necessary to calibrate the artificial voice. This was accomplished by using the General Radio Sound-Level Meter, which was already calibrated in decibels. The artificial voice was set up and suspended in the clear. The microphone of the sound-level meter was put on an extension cord and placed six feet from, and in line with, the center of the artificial voice. In order to reduce the

FIGURE 3. Block diagram of method used to calibrate the artificial voice.

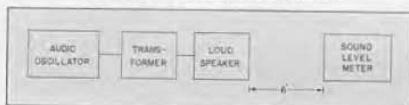

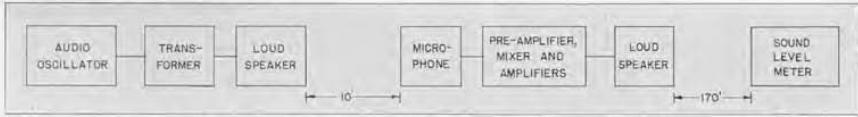

FIGURE 4. Block diagram of method used to measure the over-all characteristic of the sound system.

influence of reflections to a minimum the calibration test was conducted outdoors.

The volume of the audio oscillator connected to the artificial voice was set so that for 1000 cycles the volume was about 80 db as read by the sound-level meter. The sound-level meter was of course set for a linear response. For various frequencies ranging from 100 to 10,000 cycles per second the reading of the sound-level meter was recorded. A cathode-ray oscillograph was connected to the earphone jack of the sound-level

meter, so that the shape of the wave from the artificial voice could be constantly observed. The volume of the audio oscillator was changed, and another set of readings was taken. The frequency characteristic was found to be the same at both levels and is shown in Figure 5c.

Having the data for a set of calibration curves of the artificial voice, the apparatus was then set up for the over-all frequency response test. The artificial voice was suspended so that it would assume a position similar to that taken by the head of an actor on the stage. Since about 90% of the time the actors on the stage are about two feet in back of the white line and directly in front of a microphone, the artificial voice was placed in the same position. The sound-level meter was placed on one of the front seats of the stadium, and the oscillograph was again connected to the earphone jack of the meter.

The oscillator was turned on so that the output of the artificial voice was about 80 db at the microphone for 1000 cycles per second. The amplifier was adjusted so that the reading of the sound-level meter in the stands was about the same. Readings were taken for various frequencies ranging from 100 to 10,000 cycles per second, and the shape of the output wave was observed. This test was repeated several times.

Other tests were attempted, such as placing the artificial voice further back-stage and in between microphones, but unfortunately by this time the wind was quite strong and accurate readings could

FIGURE 5. The results of each step in the measurement are shown here.

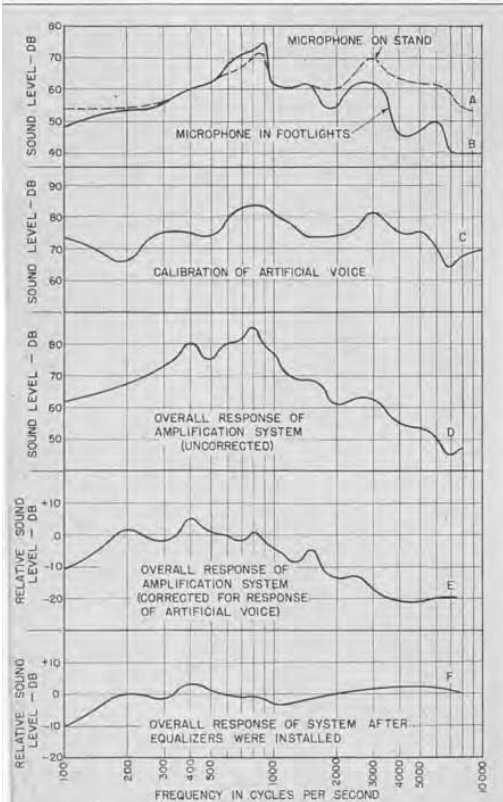



FIGURE 6. Showing the sound-level meter and oscillograph as used in measuring the over-all characteristic of the system.

not be obtained. Incidentally, it was necessary to make all the tests between the hours of 11:00 p.m. and 6:00 a.m., as this was the only time of the day that the wind died down at all.

It was interesting to note that for a slight wind, the volume of the sound in the stands varied as much as 10 and 15 db for frequencies above 800 cycles when the volume output of the artificial voice was constant. Below 800 cycles the volume level was quite constant, regardless of the wind. On a very windy night the volume of the frequencies above 800 cycles would vary as much as 25 db — the higher the frequency, the greater the variation.

RESULTS

Subtracting the response curve of the artificial voice from the over-all response curve obtained by the artificial ear, the actual over-all response curve of the Marine Stadium was obtained. As can be seen from this curve, the high frequencies are considerably attenuated.

As a result of the over-all response test a two-section high-frequency equalizer, capable of permitting a maximum equalization of 25 db, was installed in the 250-ohm line output of the stage microphone mixer unit. A control was put on the panel so that the equalization could be varied. The resulting frequency characteristic is shown in Figure 5F.

The improvement in the sound amplification system was very apparent. Speech was much clearer and the music possessed a brilliance that was previously missing.

The text and illustrations of the foregoing article were prepared by Mr. John M. Lester, under whose direction the measurements were made at Jones Beach State Park. —EDITOR

FIGURE 7. View of the grandstand and stage at Jones Beach.



MISCELLANY

● **GENERAL RADIO ENGINEERS** returning from the San Francisco I.R.E. Convention report a large and enthusiastic attendance. Particularly gratifying to us was the interest in the new General Radio instruments on display.

The new CLASS C-21-HLD primary frequency standard will be displayed at the General Radio booth at the Annual Convention of the I.R.E., to be held in New York in September. Same booth, same location as in 1937 and 1938.

● **RECENT VISITORS** to our laboratories included Mr. Henryk Mag-

nuski, Mr. Henryk Lukasiak, and Mr. Artur Hirszbandt, all of the engineering staff of the Tele-Radio-Technical Institute of Poland at Warsaw.

● **THE TABLE** of the properties of insulating materials published in our June issue has aroused considerable interest. Many readers have taken the trouble to send in corrections and additions which will aid in bringing the table up to date. The corrected table will be available some time this fall, and will be published in reprint form as well as in the *Experimenter*.

T**HE General Radio EXPERIMENTER** is mailed without charge each month to engineers, scientists, technicians, and others interested in communication-frequency measurement and control problems. When sending requests for subscriptions and address-change notices, please supply the following information: name, company name, company address, type of business company is engaged in, and title or position of individual.

GENERAL RADIO COMPANY

30 STATE STREET · CAMBRIDGE A, MASSACHUSETTS

BRANCH ENGINEERING OFFICES

90 WEST STREET, NEW YORK CITY

1000 NORTH SEWARD STREET, LOS ANGELES, CALIFORNIA

